

ARTLINE & ARTLINE XL

LIGHT IS MORE



Photo: AdriaGoulaPhoto



TECHNAL®

By  Hydro



ARTLINE

/ LIGHT IS MORE

MINIMAL DESIGN

Elegantly bringing the outdoors inside, ARTLINE window aims at providing quality, lightness and comfort.

ARTLINE's creative and contemporary design has an architectural effect on the building. The spaces' architectural features were taken into consideration during the ARTLINE's conception, resulting in a feeling of extreme simplicity, lightness and frameless windows.

ARTLINE's sophisticated minimalist design creates a light and fluid appearance, even for large fixed and openable windows.

MULTI APPLICATION

The range of applications that ARTLINE can perform is extensive, giving it a high level of functionality.

Floor to ceiling glass walls can easily be opened and closed to let the outdoors in.

ARTLINE windows heights can reach up to 4,5 m. Each sash can carry up to 1200 kg, enabling both large and heavy glazed infills.

The window's impressive dimensions, combined with a minimal visible frame width, enable interiors to be flooded with light.



Architectural studio: ANTE Architecten
Photography: www.fotovanhuffel.be

ARTLINE & ARTLINE XL

/ THE PANORAMIC SLIDING DOOR

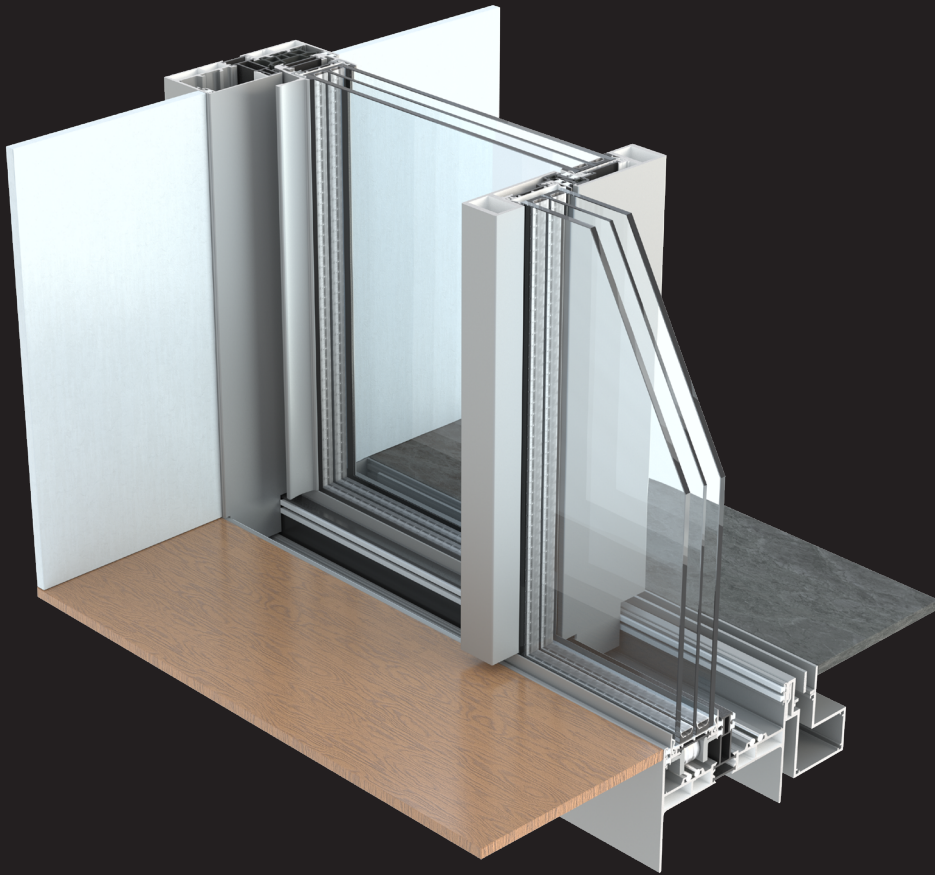

ARTLINE XL:
high performance thermally insulated
sliding door for huge openings

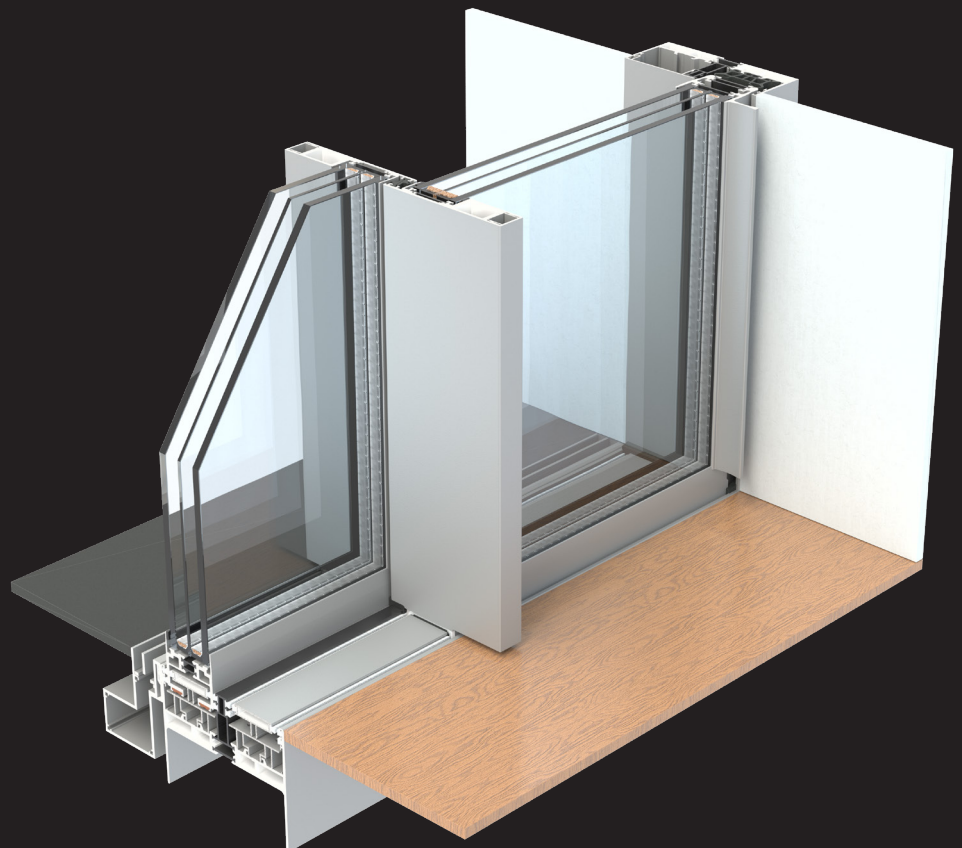

ARTLINE XL Flush:
Super minimalistic sliding
door with smallest sightline
at the meeting stile

KEY FEATURES AND INNOVATIONS

DESIGN: MINIMALISTIC

- A frameless aspect by concealing the outer frame in the building's construction.
- The sightline of the sashes is between 0 and 31.5 mm.
- Pocket solution: maximum transparency.
- Extremely slim interlocking profile (26 or 38 mm)
- Many applications available on standard version: 2 and 3 rails version, floating corner, pocket solution, fix-slide-fix solution, bi-part solution.
- Hidden gutter in flush solution
- Hidden sashes with roller in frame solution.
- No visible components: concealed drainage and hardware.

LARGE DIMENSIONS

(In standard version)

- Maximum sizes up to H = 4500 mm.
- Weight: up to 1200 kg per sash. It is recommended to motorize panes weighing over 500 kg.
- Glazing thickness up to 52 mm.

PERFORMANCES

(According to EN standards)

- **Thermal:** $U_w < 1.0 \text{ W/m}^2\cdot\text{K}$
($U_g = 0.5 \text{ W/m}^2\cdot\text{K}$, triple glazing, $T_{LW} < 0.64$, $S_w < 0.62$
1 sash + 1 fix, WxH = 3000 x 2800 mm)
- **Air permeability:** Class 4 (highest level)
- **Water tightness:** Class E900
- **Wind pressure resistance:** Class C3
- **Durability:** Cyclic test: EN1191: 50 000 cycles
- **Corrosion:** Salt spray test: EN1670 Grade 5 (highest level)
- **Safety:** Burglar resistance: RC2

ACCESSIBILITY AND COMFORT

- Ground-recessed for total access comfort on all applications.
- Optional motorization in all applications in collaboration with LIBERDA Antriebstechnik GmbH.

SUSTAINABILITY

- Available in Hydro CIRCAL[®], aluminium made with a minimum of 75% recycled end-of-life aluminium. This aluminium has one of the lowest CO₂ footprint worldwide: 2.3 kg of CO₂/kg of aluminium.
- EPD on demand

MAXIMUM LIGHT

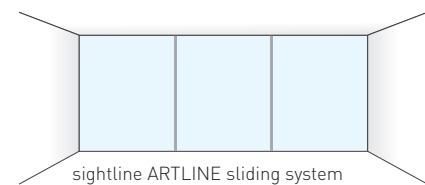
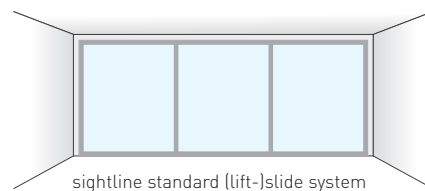

ARTLINE

/ AESTHETIC LIGHTNESS

The ARTLINE sliding door is constructed from insulated aluminium profiles and is specially designed to maximise the clear glass area and openness of the architectural design. The threshold is lowered into the floor and the frame is built in inside the walls at the sides to give a frameless appearance. Handles are stylishly integrated into the profiles and further enhance the minimalist design.



View of the open pane, showing upper frame built into the false ceiling.



Detail of the central overlap of two panes, showing lower frame flush with the outer and inner pavement. The depth of the pane upright depends on the pressure it must support so that the glass does not exceed its stress threshold.



Photography: Leszek Ogrodnik - www.quadroom.pl



Photography: infofotoama.be

ARTLINE

/ AESTHETIC LIGHTNESS

HIDDEN FRAMES

The frames (side, floor and ceiling) can be recessed and disappear almost completely from view. This way, only the interlocks of the panes remain visible, featuring a sightline that can be 38 mm or 26 mm wide (as per client specification), and the profile depth that varies depending on the inertia required to support the wind pressure according to the window surface area. Also the handles are discretely integrated in the sliding system. This design translates into a slenderness that works beautifully in architectural projects aiming at the utmost transparency.

POCKET SOLUTION

The extremely slim interlocks in addition to minimalistic pocket solution are able to offer an incredibly stunning transparency.

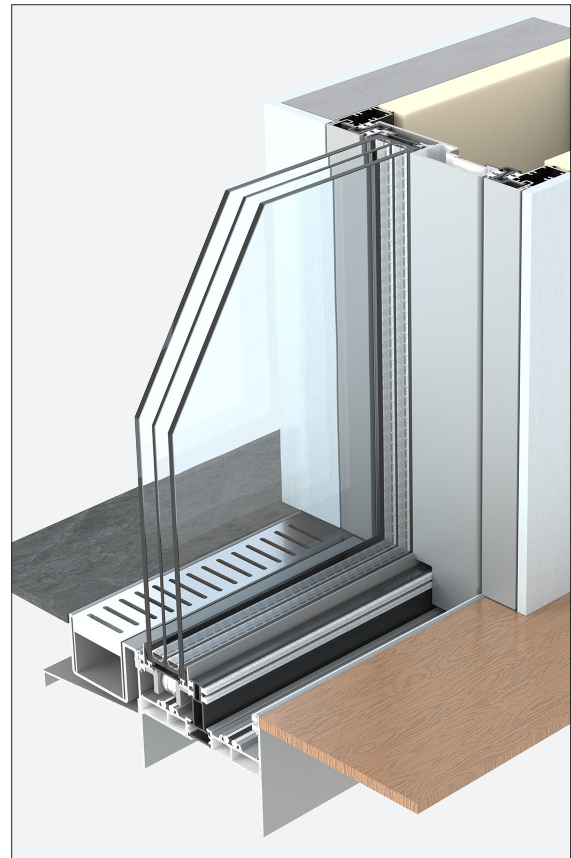

ARTLINE XL Pocket solution

SECURITY AND PERFORMANCE

ARTLINE manages to convert these large glazed walls into a resistant wall—tested for water tightness, air permeability and intrusion resistance. Its system design has passed stringent certification tests.

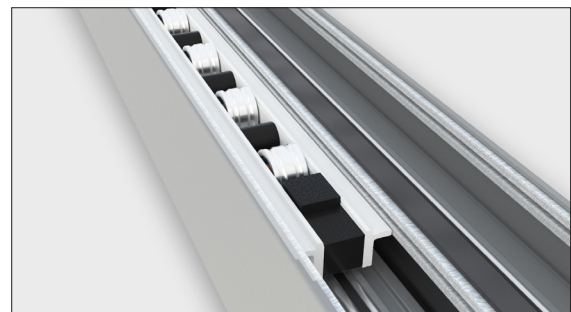

Each pane slides on two sets of wheels, like the one pictured. Each trolley has four double marine-quality stainless steel wheels that slide on a double stainless steel rail supporting 500 kg of weight, requiring minimal pushing effort. The 8-wheel roller can manage up to 1200 kg. It is advisable to motorize panes weighing > 500 kg.

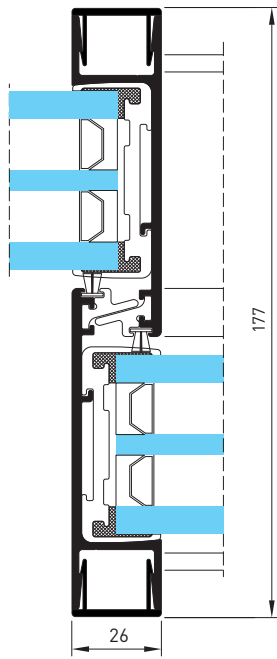

Central mullion 26 mm
(ARTLINE XL)

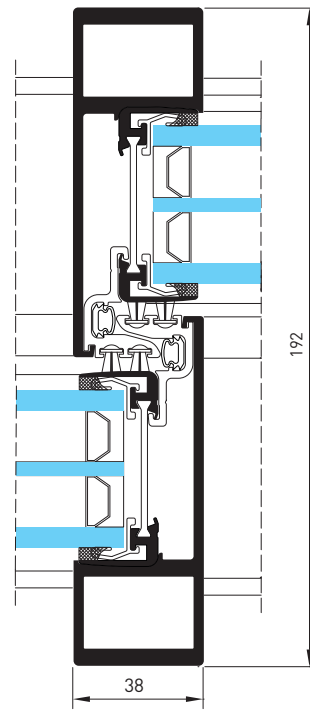

Central mullion 38 mm
(ARTLINE XL)



Architect: Robert Konięczyński
Photography: Leszek Ogrodnik - www.quadroom.pl

ARTLINE XL

/ OPEN CORNER

OPEN CORNER

ARTLINE slider provides external or internal corner solution to design even more original projects. It enables users to configure the frame to corner at 90°, without the need for a corner post. When the panes are opened, the corner opens wide up, blurring the line that separates the inside from the outside. When closed, the panes on either side connect, sealing out water and air.

90 ° corner contact.
Glazing from 40 to 52 mm
(ARTLINE XL)

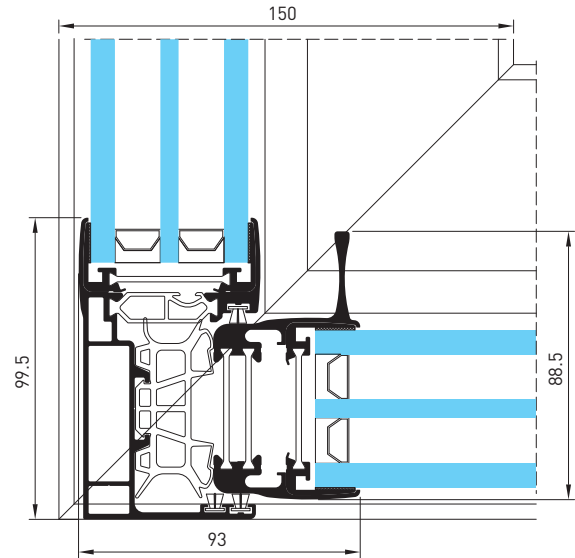



ARTLINE XL RIF

/ WITH ROLLERS IN THE FRAME

The Artline XL RIF is a version with the rollers integrated in the frame.
In this configuration the sashes are completely invisible except for the interlock with a sightline of 26 mm.
This solution is available for a 2 and 3 rail application.

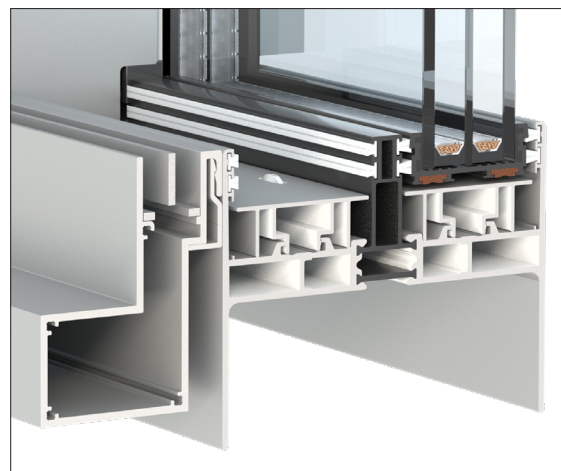
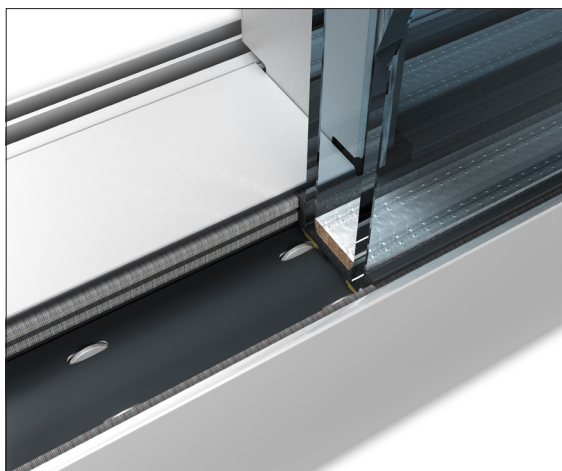

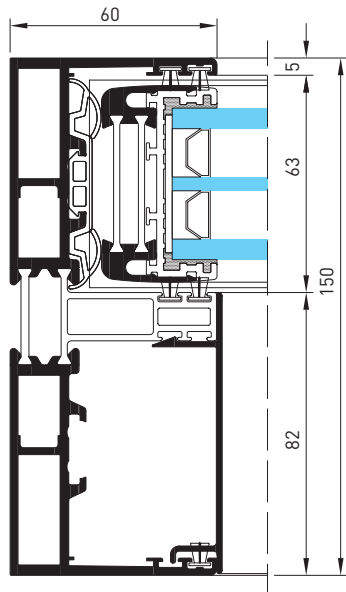

Side contact between pane and frame
 Max. glazing of 45 mm
 [ARTLINE XL RIF]

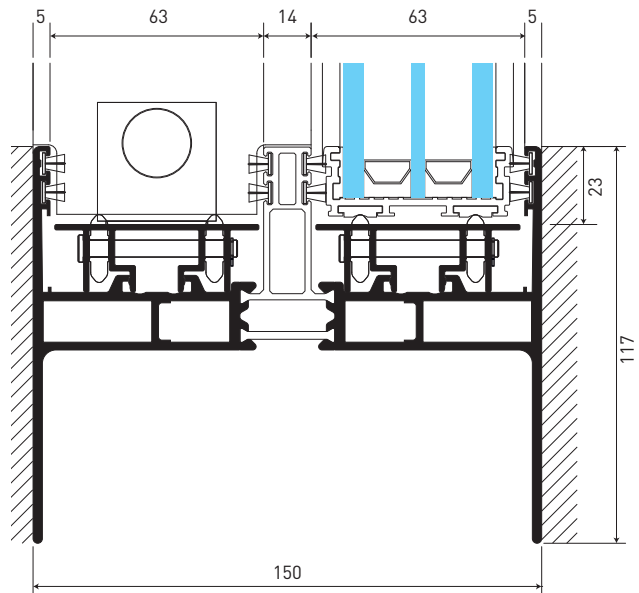

Contact of pane and lower frame
 Max. sash weight of 500 kg
 [ARTLINE XL RIF]



Architect: SIGGE architects Oy, Pekka Mäki
Photography: Vesa Loika Design

ARTLINE XL FLUSH

/ FLUSH THRESHOLD

The Artline XL is also available in a completely flush threshold. In that version the rollers are integrated in the frame but are also invisible.

This solution ensures a seamless connection of indoor and outdoor living spaces, bringing the Outside almost literally inside your building. It also creates user comfort and accessibility.

This solution is available for a 2 and 3 rail application with 26 mm interlock.



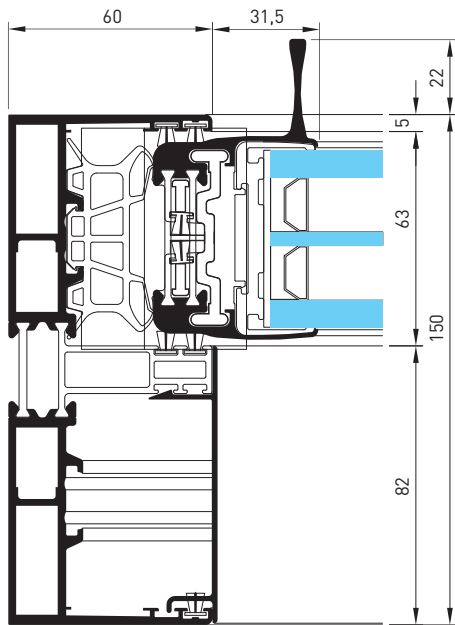
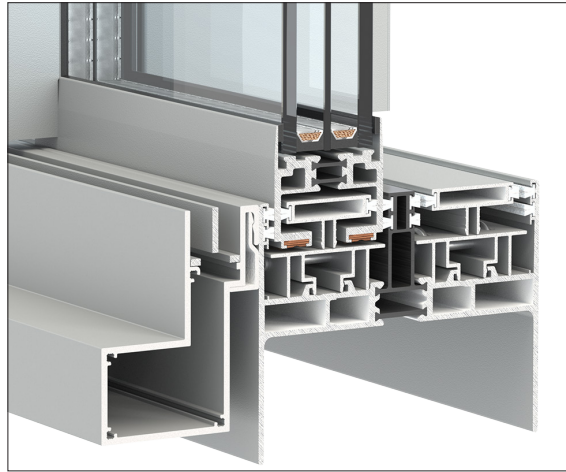
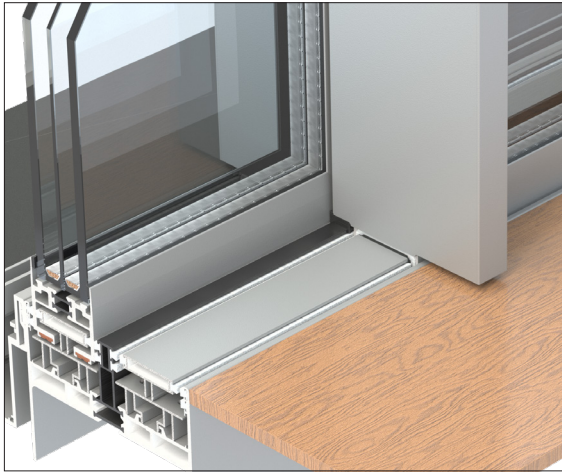

Horizontal section of sash and frame
max glazing of 52 mm
(ARTLINE XL Flush)

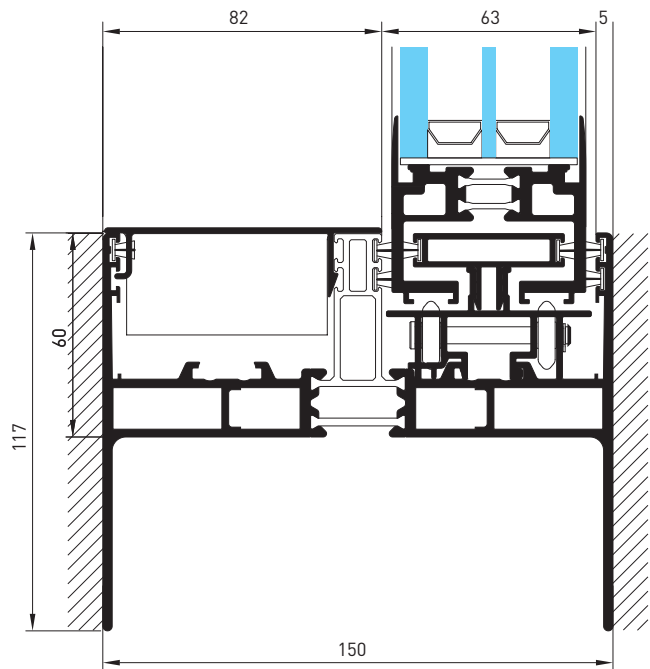

Vertical section of sash and frame
max sash weight of 500 kg
(ARTLINE XL Flush)

APPLICATIONS

All configurations are motorizable. It is advisable to motorise panes weighing > 500 kg for safety reasons.

Applications are depending on solutions.

Available with all thresholds:

2 rails

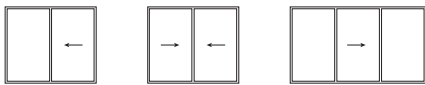

3 rails



Available on standard threshold:

2 rails



3 rails



2 rails

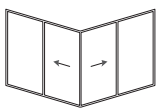

3 rails

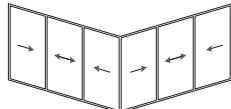

combination of 2 rails and 3 rails

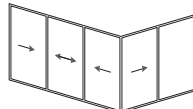

Photo: Adrian Toon

CHARACTERISTICS & PERFORMANCES

CHARACTERISTICS					
Applications	Sash weight	Visible sightline of the interlock	Building depth frame	Sash depth	Max glazing sash
ARTLINE	up to 320 kg	26 or 38 mm	125 mm	47 mm	42 mm
ARTLINE XL	up to 500 kg*	26 or 38 mm	150 mm	57 mm	52 mm
ARTLINE XL RIF	up to 500 kg	26 mm	150 mm	57 mm	45 mm
ARTLINE XL Flush	up to 500 kg	26 mm	150 mm	57 mm	52 mm
ARTLINE XL Pocket	up to 500 kg*	38 mm	150 mm	57 mm	52 mm

* up to 1200 kg upon request

TIGHTNESS PERFORMANCES (according EN12207, EN12208, EN12210) & BURGLARY RESISTANCE (according EN1627-EN1630)						
Applications	Configuration	Dimensions in mm (W x H)	Air permeability	Water tightness	Wind resistance	Burglary resistance
ARTLINE	2 track, slide-fix	2400 x 2500	4	E750	C3	class RC2
ARTLINE XL	2 track, slide-slide	4000 x 4500	4	9A	C3	class RC2
ARTLINE XL RIF	2 track, slide-slide	4000 x 2800	4	E900	C2	-
ARTLINE XL Flush	2 track, slide-slide	4000 x 2800	4	8A	C3	-

ACOUSTIC PERFORMANCES								
Applications	Configuration	Dimensions in mm (W x H)	Glazing	Thickness in mm	Attenuation glazing (dB)		Attenuation ARTLINE (dB)	
					R_w [C;C _{tr}]	R_{Atr}	R_w [C;C _{tr}]	R_{Atr}
ARTLINE	2 track, slide-slide	3950 x 2400	66.2 - 20 - 44.2	42 (double)	50 [-2;-8]	42	39 [-1;-2]	37
ARTLINE XL	2 track, slide-slide	3950 x 2400	66.2 - 12 - 6 - 12 - 44.2	52 (triple)	50 [-2;-6]	44	37 [-1;-1]	36

THERMAL PERFORMANCES - U_w (in W/m ² K)					
Applications	Configuration	Dimensions in mm (W x H)		U_w with $U_g = 0.5$ W/m ² K / $\Psi_i = 0.039$ W/mK	
					U_w with $U_g = 1.0$ W/m ² K / $\Psi_i = 0.051$ W/mK
ARTLINE	2 track, slide-fix	3000 x 2800	U_w	0.98	1.48
			TL_w	0.62	0.62
			S_w	0.60	0.60
ARTLINE XL	2 track, slide-fix	3000 x 2800	U_w	0.91	1.49
			TL_w	0.62	0.62
			S_w	0.60	0.60
ARTLINE XL RIF	2 track, slide-fix	3000 x 2800	U_w	0.96	1.34
			TL_w	0.62	0.63
			S_w	0.61	0.61
ARTLINE XL Flush	2 track, slide-fix	3000 x 2800	U_w	0.96	1.42
			TL_w	0.62	0.62
			S_w	0.60	0.60



Architect: SIGGE architects Oy, Pekkä Mäki
Photo: Vesa Loikas



MATERIALS AND COMPONENTS

ARTLINE is made of Hydro CIRCAL®, recycled low carbon aluminum. It is a prime quality aluminum made with a minimum of 75% recycled end-of-life aluminum (post-consumer scrap). Hydro CIRCAL® has one of the lowest CO₂ footprint worldwide: 2.3 kg of CO₂ per kilo of aluminum.

- The aluminum profiles are extruded from alloys 6060 Building compliant with EN 12020, EN 573-3, EN 515 and EN 775-1 to 9.
- As with all TECHNAL systems, only high-quality materials and components are used to ensure reduced maintenance and optimal long-term performance.
- Accessories are made of aluminum or aluminum alloy.
- The window assembly features EPDM seals.
- The screws are made of stainless steel.

FINISHES

ARTLINE boasts a wide array of finishes and textures to let architects and decorators choose the right solution for their design and meet the demands of both new construction and rehabilitation projects.

- Anodized as per QUALANOD Quality Label specifications.
- Lacquered with a wide range of colours as per QUALICOAT Quality Seal specifications.



IMAGINE WHAT'S NEXT

Hydro Building Systems Middle East W . L . L

P.O. Box: 21848, Manama, BAHRAIN

www.technal-me.com

T: +973 17225777 | F: +973 17217799 | E: technal-hbsme@hydro.com

 TechnalME  [technal_middleeast](https://www.instagram.com/technal_middleeast)  TechnalME  TECHNAL Middle East